

PCSA Printing Guide

Order Number AA-MF84A-TH

October 1988

Revision/Update Information: This updated document supersedes the *Printing Guide*, Version 2.0, order number AA-KY01B-TH.

Operating System and Version: VAX/VMS, Version 4.7, 5.0 or later
DOS, Version 3.2 and 3.3 or later

Software Version: DECnet/PCSA Client, Version 2.1
VAXmate Services for MS-DOS,
Version 2.1
VAX/VMS Services for MS-DOS,
Version 2.1
VAXmate Standalone, Version 2.1

**digital equipment corporation
maynard, massachusetts**

First Published, 1987
Revised, October 1988

The information in this document is subject to change without notice and should not be construed as a commitment by Digital Equipment Corporation.

Digital Equipment Corporation assumes no responsibility for any errors that may appear in this document.

The software, if any, described in this document is furnished under a license and may be used or copied only in accordance with the terms of such license. No responsibility is assumed for the use or reliability of software or equipment that is not supplied by Digital Equipment Corporation or its affiliated companies.

Copyright ©1987, 1988 Digital Equipment Corporation.

All Rights Reserved.
Printed in U.S.A.

The Reader's Comments form on the last page of this document requests the user's critical evaluation to assist in preparing future documentation.

The following are trademarks of Digital Equipment Corporation:

DDCMP	LJ250 Companion Color Printer	RSX
DEC	LJ252 Companion Color Printer	RT
DECmate	LN03	RX33
DECnet	LN03 Plus	ThinWire
DECconnect	LN03R ScriptPrinter	VAX
DECserver 200	MicroVAX	VAXcluster
DECUS	P/OS	VAXmate
DELNI	PCMAIL	VMS
DEMPR	PrintServer 40	VT
DESTA	Professional	WPS
LA50	Rainbow	WPS-PLUS
LA75 Companion	ReGIS	
LA210	RSTS	digital [™]
Letterprinter		

3Com and EtherLink are trademarks of 3Com Corporation.

COMPAQ is a registered trademark of COMPAQ Computer Corporation.

IBM and Personal System/2 are registered trademarks, and NETBIOS, Personal Computer AT, Personal Computer XT, and Proprinter are trademarks of International Business Machines Corporation.

MICOM-INTERLAN is a registered trademark of MICOM Systems, Inc.

Microsoft, MS, and MS-DOS, and Multiplan are registered trademarks of Microsoft Corporation.

PostScript is a registered trademark of Adobe Systems, Inc.

Contents

About This Manual	vii
--------------------------	-----

1 Introduction

An Overview of the Printing Process	1-2
Serial and Parallel Ports for Local Workstation Printing	1-3
Network Printer Services	1-6
Logical Devices	1-6
Printers and Printer Drivers in MS-Windows	1-7
Printing Modes	1-8
Printing from Applications	1-8

2 Printing from MS-Windows

Using the Control Panel	2-2
Making Printers Available to Your Workstation	2-4
Setting Up Your Printer	2-7
Associating Printer Types and Logical Devices	2-8
Matching Printer Port and Printer Settings	2-9
Selecting a Default Printer	2-11
Printing and Copying Files	2-13
Using the MS-Windows Print Command	2-13
Using the MS-Windows Copy Command	2-15
Controlling the Print Job	2-16
Allocating Printing Resources	2-17
Interrupting or Canceling Print Jobs	2-17
Printing to a File	2-19
Printing the Contents of the Screen	2-21

3 Local Printing from DOS

Redirecting Logical Devices to Local Ports	3-2
Setting Printer Characteristics	3-3
Matching Printer Port and Printer Settings	3-7
Printing and Copying Files to a Local Printer	3-9
Using the PRINT Command	3-9
Using the COPY Command	3-10
Controlling the Print Job	3-11
Remove Files by Name from the Print Queue	3-11
Remove All Files from the Print Queue	3-12
Show Printer Queue Status	3-12
Printing the Contents of the Screen	3-12

4 Remote Printing from DOS

Redirecting a Logical Device to a Remote Printer	4-2
Setting Your Default Remote Printer	4-3
Sending a File to a Remote Printer	4-4
Using the NET PRINT Command	4-4
Checking Print Queue Status	4-5
Disconnecting from a Remote Printer	4-6

Index

Figures

1-1 Overview of the Printing Process	1-2
1-2 VAXmate Serial Printer Port and Serial Communications Port	1-4
1-3 Workstation Using Local and Remote Printers	1-6
2-1 Control Panel Window	2-3
2-2 Add Printer Dialog Box	2-5
2-3 Setup Menu Commands	2-7
2-4 Connection Dialog Box	2-8
2-5 Communications Settings Dialog Box	2-10
2-6 Default Printer Dialog Box	2-12

2-7	Print Dialog Box	2-14
2-8	Copy Command Dialog Box	2-15
2-9	Setting Up Connections to Print to a File	2-20

Tables

1-1	VAXmate Workstation Default Port Settings	1-5
2-1	Installation and Setup Functions	2-4
2-2	Selecting Printers	2-6
2-3	Ways to Send Text to a Printer from MS-Windows	2-13
2-4	Spooler Priority Menu Commands	2-17
2-5	Spooler Control Menu Commands	2-18
3-1	Setting Printer Types with MODE command	3-5
3-2	Default Settings for MODE Command Communications Setup	3-9
3-3	Ways to Send Text to a Local Printer	3-9
3-4	Ways to Send Screen Contents to a Local Printer	3-12
4-1	Network Commands for Setting Default Remote Printers . . .	4-4
4-2	Commands for Checking Print Queue Status	4-5
4-3	How to Redirect a Remote Printer	4-6

About This Manual

The Personal Computing Systems Architecture (PCSA) is an extension of DIGITAL systems and networking architecture that merges VMS and MS-DOS environments. The PCSA network may include VAX, MicroVAX, or VAXmate servers running VAX/VMS Services for MS-DOS or VAXmate Services for MS-DOS. It also includes the DECnet/PCSA Client software that runs on PC workstations and on VAXmate workstations. Other PCSA products include the ThinWire Ethernet products and other peripherals, such as the LN03 Plus and the LA75 Companion printers.

The DIGITAL PCSA network fully integrates all the elements of personal and corporate computing required for direct information access and sharing. Thus, it has computing and communication capabilities substantially better than those of conventional PC local area networks (LANs).

Manual Objectives

The manual explains how to use MS-Windows and DOS to set up or change workstation configurations for printing with a standalone workstation or a workstation connected to a network, and how to print files and the contents of screens.

This manual is intended as companion documentation to the on-line Information System and the *Microsoft Windows User's Guide*, the *MS-Windows Enhancements*, the *MS-DOS Reference Manual*, and *Using Networks from Your Workstation*.

Intended Readers

This manual is intended for workstation users familiar with PCSA MS-Windows or DOS who want to change their workstation configuration for use with local or, in a network environment, remote printers.

You should have access to information about the printers you want to use. Your printer hardware manual contains information you need to install your printer and to set baud rates, protocols, and other variables. If your workstation is connected to the network, see your system administrator for information about the printers you can use with servers.

To use Chapter 2 of this manual, you should be familiar with MS-Windows menus and commands.

To use Chapter 3 of this manual, you should be familiar with DOS.

To use Chapter 4 of this manual, your workstation should be connected to the PCSA network and you should be familiar with DOS.

The manuals listed in the following table contain information that can be helpful to you.

Associated Manuals

See...	For...
Your printer hardware manuals	Information specific to your printers that is not covered in this guide, such as installing the printer and adjusting the printer settings for baud rate and protocol
Your workstation handbook and configuration guides	Information specific to your workstation that is not covered in this manual
<i>Microsoft Windows User's Guide, MS-Windows Enhancements and MS-DOS Reference Manual</i>	Additional information about MS-Windows and the DOS commands covered in this manual
<i>DOS Enhancements</i>	Additional information about the DOS commands to use for printing
<i>Using Networks from Your Workstation</i>	Additional information about PCSA network commands covered in this guide
<i>VAX/VMS Services for MS-DOS Administration Guide</i>	Information about setting up print queues on a VAX/VMS server

Manual Organization

The following table can help you locate information in this guide.

Chapter 1	Introduces the PCSA printing process and includes special information you need for printing with applications.
Chapter 2	Explains how you can use MS-Windows to change the workstation printing configuration your system administrator set up for you for both local and remote printers. Also explains how to print files and the contents of your workstation screen, and how to control the print job.
Chapter 3	Explains how you can use DOS commands to change the workstation printing configuration your system administrator set up for you for local printers. Also explains how to print files and the contents of your screen, and how to control the print job using DOS commands.
Chapter 4	Explains how you can use MS-Net commands from the DOS prompt to connect to and use remote printers in the PCSA network.

Conventions Used

The following conventions are used in this manual:

Convention	Meaning
red type	In examples, what you type is shown in red.
Ctrl/P	Hold down the Ctrl key while you press the P key.
enter	Type all text, spaces, and punctuation marks exactly as they are printed. Then, press the key indicated.
Enter	Press the Enter key.
Shift/Prt Sc	Hold down the Shift key while you press the Prt Sc key.
Ctrl/Alt/Prt Sc	Hold down the Ctrl and Alt keys while you press the Prt Sc key.
workstation	Refers to a VAXmate or PC computer used on a network, or a standalone VAXmate computer.

In the index, tables and figures are indicated by “t” and “f,” respectively.



1

Introduction

With PCSA MS-Windows or DOS, you can print files on a *local printer*— a printer plugged into the back of your workstation— or a *remote printer*— a printer connected to a server on the PCSA network.

The VAXmate standalone workstation is configured for use with DIGITAL serial printers. In a PCSA network, your system administrator is responsible for setting up your local and remote printers, and DOS and MS-Windows to use those printers. When you start your workstation, you can begin printing immediately. However, you can change the way your printers are set up, and the way DOS and MS-Windows use those printers. The chapters in this book provide information for changing the established printing settings.

Before you can change any of your printing settings, for either MS-Windows, DOS, or an application, you should understand some basic concepts about printing, configuring your workstation, and local and remote printers.

This chapter introduces you to the printing process in the PCSA environment and to the following concepts:

- Serial and parallel ports for local workstation printing
- Network printing services
- Logical devices and their relationship to printer ports, printers, applications, and data to be printed
- The printer drivers for MS-Windows
- How printing from some applications can differ from printing directly from MS-Windows or DOS

An Overview of the Printing Process

Before you change any of your workstation printing settings, it is helpful to understand the process of printing from MS-Windows, DOS, or an application. An overview of the printing process is illustrated in Figure 1-1 and the list of steps following the figure. Later chapters explain the commands you use to set up and use your printers.

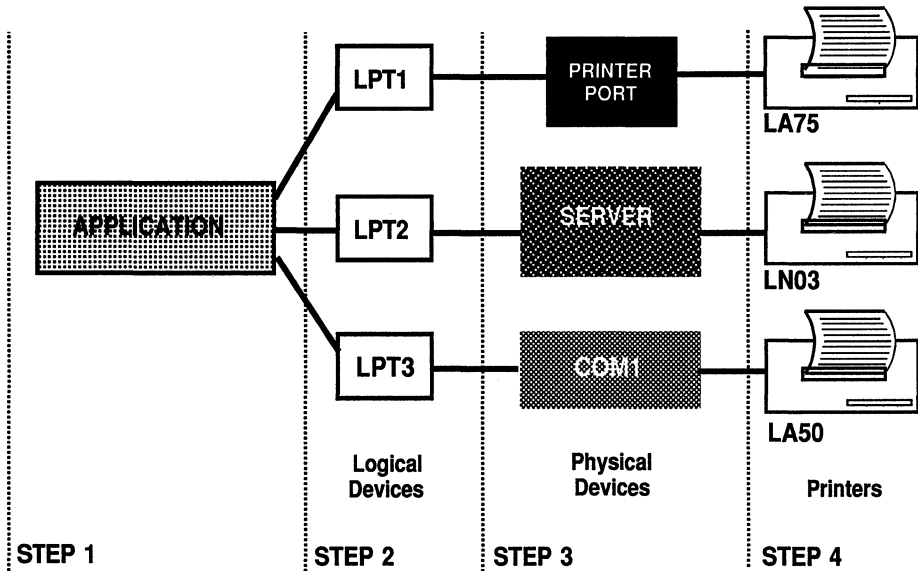

MR-1001-SI

Figure 1-1 Overview of the Printing Process

1. You start the printing process when you tell either MS-Windows, DOS, or an application to print a file. Later chapters explain the commands you can use to send files to a printer.
2. MS-Windows, DOS, or the application you are using sends the data to a *logical device*, which acts like a funnel to channel the data to the correct physical device; for example, a printer port on your workstation.

There are three logical devices (LPT1, LPT2, LPT3) that can be associated with the physical devices.

3. The logical device channels the data to a *physical device*, which is either a local printer port on the back of your workstation or a remote printer connected to a server on the network. Your workstation automatically directs LPT1 to local printer ports. You can *redirect*, or assign, logical devices to other physical devices on your workstation or on the network.

The local printer ports have certain characteristics, such as the rate at which they transmit or receive data. Your local printer has similar characteristics. You must be sure that the local printer port characteristics and the printer characteristics match.

The characteristics of remote printers are set up by your system administrator. On VAX servers, the system administrator uses a utility called PCSA_ADMIN.COM to define the printer queues for some DIGITAL printers. For other printers, the system administrator uses VAX/VMS utilities and commands to set up the printer queues, printer forms, and other information needed before making the printer available for use on the server.

On the VAXmate server, the system administrator uses DOS commands, such as the MODE command described in Chapter 3 to set up the printers.

4. The physical device sends the data to the printer, and the file prints.

Your printers connect directly to the physical devices. You must identify the local printers you have connected to your workstation and which remote printers you want to use. See your system administrator for a list of the remote printers that are available for your use.

Serial and Parallel Ports for Local Workstation Printing

Serial and parallel ports are the hardware connections on your workstation. You use serial ports for connecting serial printers and communications devices, and parallel ports for connecting parallel printers. A serial or parallel port can come installed on your workstation. You can also install ports as optional hardware. For information about the kind of port installed on your workstation, see your workstation hardware documentation.

There are two serial ports on the back of the VAXmate workstation: the Serial Printer Port (SPP) and the serial communications port (COM1), as shown in Figure 1-2. You can connect serial printers to the serial ports.

With an expansion box, you can install parallel printer ports and additional serial ports. To connect a parallel printer to your workstation, you must have a parallel printer port installed. For information on installing and connecting your parallel printer, see your workstation and printer manuals.

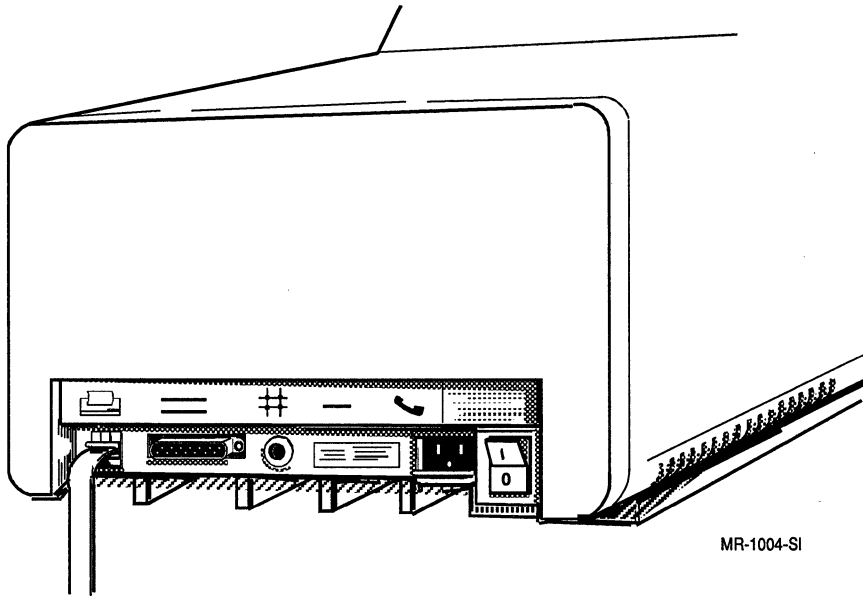

Figure 1-2 VAXmate Serial Printer Port and Serial Communications Port

Serial ports have settings that control how the port sends and receives data. Serial printers have similar settings. The following workstation port settings and printer settings must match before you can send a file to print:

- Baud rate
- Parity
- Data bits or word length
- Stop bits
- Retry
- Modem control or “handshake”

For a listing of the factory-installed printer settings, see your printer manual. For the default settings for a serial communications card you install, see your serial card hardware documentation. The default settings for the VAXmate workstation serial ports are listed in Table 1-1.

Table 1-1 VAXmate Workstation Default Port Settings

Port	Baud Rate	Parity	Stop Bits	Data Bits
SPP	4800	None	1	8
COM1	9600	None	1	8

There are three ways to match these settings:

- Check and set the switches on the printer to match the default workstation settings. Changing the printer switches makes the changes to the printer settings permanent. See your printer manual for directions.
- Change the port settings by using the DOS MODE (for a VAXmate workstation) or the DIGITAL DECMODE (for PC workstations) commands communications setup. You can add the MODE or DECMODE commands to the AUTOEXEC.BAT file. Then, each time you restart the workstation, the port settings are set automatically. For more information on the MODE and DECMODE commands, see Chapter 3.

NOTE

To change the SPP settings to match the printer, you must use the MODE command.

- Use the MS-Windows Control Panel to change the communications port settings. For information on using the Control Panel, see Chapter 2.

Network Printer Services

In addition to the workstation printer ports to which you can connect local printers, PCSA services let you use printers connected to servers on the network. Your workstation can use printers connected to a server as if they were plugged directly into your workstation.

Figure 1-3 shows a simple configuration of a workstation and printers in a network. The figure shows a local printer connected to the serial printer port on the workstation and a remote printer connected to the workstation through the server.

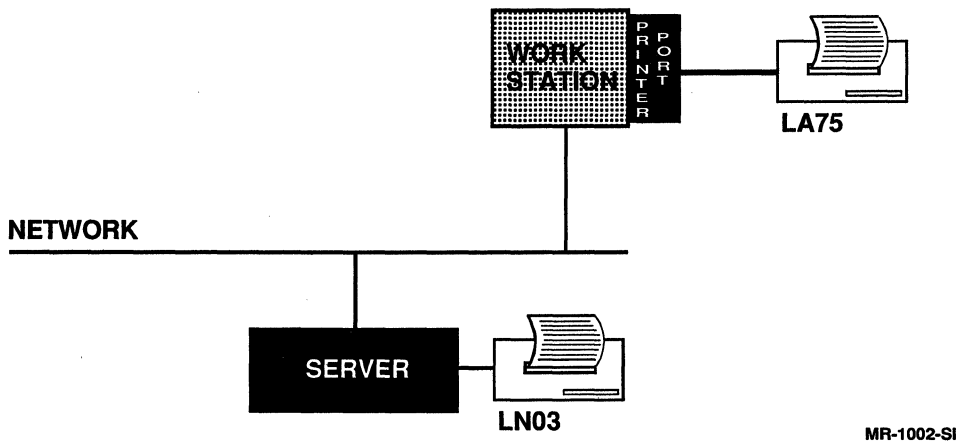

MR-1002-SI

Figure 1-3 Workstation Using Local and Remote Printers

Logical Devices

Logical devices are like pointers that channel data from an application to local printer ports and printers or to remote printers. Most applications and commands use logical devices instead of physical printer ports when they send a file to print. Before you can print, you must be sure that the logical devices point to the physical printer port or remote printer you want to use.

There are three logical devices: LPT1 (or PRN), LPT2, and LPT3. When you start your workstation, the workstation software assigns LPT1 to a local port.

On a VAXmate workstation, LPT1 is assigned to the Serial Printer Port (SPP). If you have installed a parallel printer port in a VAXmate expansion box, you should redirect LPT1 to the parallel printer port before you try to use it. For information on redirecting LPT1, see Chapter 3.

On a workstation with only parallel printer ports installed, the logical devices are assigned to the parallel printer ports.

When you send a file to be printed from either MS-Windows or DOS, the file is sent to the logical device, which channels the data to the correct printer.

For more information about redirecting logical devices to the local ports on your workstation and the print servers available to you on the network from both MS-Windows and DOS, see Chapters 2, 3, and 4.

Printers and Printer Drivers in MS-Windows

MS-Windows uses *printer driver files* to tailor general printing functions for different kinds of printers.

The VAXmate workstation includes printer driver files for the following supported serial printers:

- LA50
- LA75 Companion (DEC and STD)
- LN03 Plus
- LN03 Plus with ISO/PC cartridge (DEC and STD)
- LN03R
- LA210 Letterprinter (DEC, STD)
- PrintServer 40

In addition, the PCSA MS-Windows includes printer driver files for unsupported printers. For a list of supported and unsupported driver files available in MS-Windows, select the Add New Printer command from the Control Panel Installation menu. For information about unsupported driver files, see your Software Product Description (SPD).

When you configure your workstation and printer, you tell the workstation what kind of printers you are using and which printer driver files to use. In addition, you add a printer and printer driver file using the Control Panel Installation menu. For more information on adding printers in MS-Windows, see Chapter 2.

Printing Modes

Some printers, for example the LA75 Companion, have more than one mode of operation:

DEC mode	The printer has full use of the DIGITAL printer driver files and printer function.
STD mode	A DIGITAL printer emulates an IBM Proprinter.
HP mode	A DIGITAL serial printer emulates a Hewlett-Packard ink jet printer.

When you configure your workstation, you must set the mode in which the printer should operate. For more information on setting printer characteristics, see Chapters 2 and 3.

Printing from Applications

The following list includes information about applications printing from MS-Windows and DOS. For more information, see your application documentation.

- Using printing commands

Many applications have their own print commands. Whenever possible, use the application print command to send application files to a printer. For applications that do not have print commands, use the MS-Windows Print command or the DOS PRINT command.

- Using LPT1

Some applications always direct data to be printed to LPT1. When using an application that always prints using LPT1, you must redirect LPT1 to the printer you want to use before running the application. For information on redirecting logical devices, see the MODE command in Chapter 3 or the NET USE command in Chapter 4.

- Selecting printer types

To print to an LA75 Companion in STD mode (emulating an IBM Proprinter) from an application, specify the printer type to the application as IBM Proprinter.

- **Printing screens**

From MS-Windows and DOS, you can print the contents of the whole screen by pressing the Shift/Prt Sc keys. Shift/Prt Sc always directs data to LPT1.

From the DOS prompt, you can also print to the local printer on LPT1 using *line echo*, which prints what is displayed on the screen character by character. To use line echo, press the Ctrl/P keys. Not all applications support line echo; if an application does not support line echo, nothing prints after you press Ctrl/P as long as you are using the application. When you return control to MS-Windows or exit to DOS, line echo starts again. Press Ctrl/P again to stop line echo.

- **Selecting default printers**

Some applications let you select a default printer from within the application. You can use the Control Panel in the application to select a printer from the list of printers you have made available to MS-Windows. For more information, see your application documentation.

- **End-of-file markers**

Some applications do not include an End-of-file marker when they send a file to the printer. If you send a file to a remote printer, and the file does not print, the server may be waiting for an End-of-file marker. From the application, press the Ctrl/Alt/Prt Sc keys to send an End-of-file marker to the server. Printing should begin then. If the file still does not print, exit from the application. Printing should begin then.

2

Printing from MS-Windows

After you start your workstation, you can begin to print right away. VAXmate standalone workstations are configured for using DIGITAL serial printers. In a network, your system administrator is responsible for setting up your workstation for using local and remote printers from MS-Windows. However, you can change the way your workstation is set up to print. To change the workstation configuration, you must:

1. Connect the printer and assign a logical device
2. Identify the printer types you have
3. Identify the printer types associated with the logical devices
4. Select the default printer

When you start your workstation and MS-Windows, your AUTOEXEC.BAT file and WIN.INI file give MS-Windows information about your workstation and printer configuration, such as your default printer, the logical device for the printer connection, and the serial port settings.

You can change the information your workstation uses for printing with:

- DOS MODE command (VAXmate workstations)
- DIGITAL DECMODE command (PC workstations)
- DIGITAL USE command
- MS-Windows Control Panel

You use the DOS MODE or DIGITAL DECMODE commands to redirect logical devices to local printer ports and set characteristics for the Serial Printer Port (SPP). Use the MODE or DECMODE commands before you start MS-Windows. For information on the MODE or DECMODE command, see Chapter 3.

You use the USE command from the MS-DOS Executive window to redirect logical devices to remote printers. Alternatively, you or your system administrator can use the Configuration Aide to add the USE command to your key diskette and to the AUTOUSER.BAT file, which runs each time you start your workstation.

NOTE

When you use the Configuration Aide to add a remote printer connection to your AUTOUSER.BAT file, you must supply the service name for the printer, as assigned by your system administrator. When you later select your default printer, using the Control Panel, the mode of the your default printer must match the mode of the printer service you set up using Configuration Aide. For example, if your default printer uses portrait mode, the service you use must also print using portrait mode. Otherwise, the results are unpredictable.

See your system administrator or *Using Networks from Your Workstation* for more information on the Configuration Aide.

The Control Panel changes the printer configuration and updates the WIN.INI file with the printer configuration information.

This chapter explains how to:

- Use the Control Panel
- Make a printer available to your workstation
- Set up your printer
- Print and copy files
- Control the print job
- Print to a file
- Print the contents of the screen

Using the Control Panel

The Control Panel is an application that lets you change some aspects of the printer configuration. The changes take effect immediately. In addition, the Control Panel updates the WIN.INI file, which runs when you restart MS-Windows. For more information on the WIN.INI file, see the *Microsoft Windows User's Guide*.

To run the Control Panel:

1. In the MS-DOS Executive window, select the **Run** command from the File menu.

The MS-DOS Executive window displays the Run command dialog box.

2. In the dialog box, enter:

CONTROL

The Control Panel window is displayed, as shown in Figure 2-1.

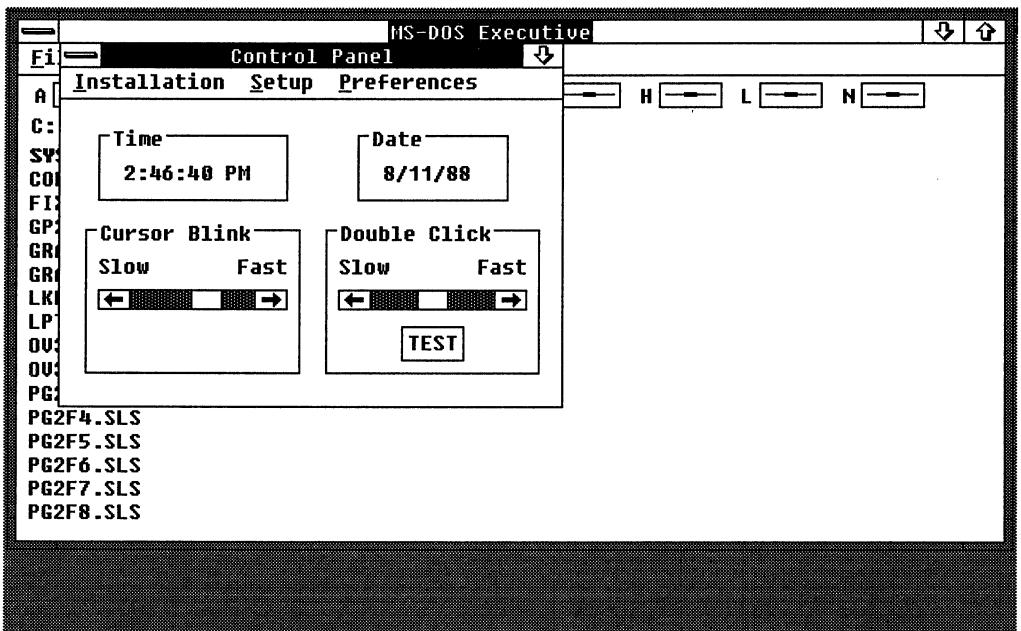

Figure 2-1 Control Panel Window

Select the Installation and Setup menu titles to set up or make changes to printer and serial port settings. Table 2-1 shows the Installation and Setup menu functions.

For additional information on using MS-Windows and the Control Panel, see the *Microsoft Windows User's Guide*.

Table 2-1 Installation and Setup Functions

Menu Title	Command	Function
Installation	Add New Printer	Add a printer driver file
	Delete Printer	Delete a printer driver file
Setup	Connection	Associate a logical device with a port or file
	Printer	Select default printers and printer output modes
	Communications Port	Match serial printer port settings to the printer settings

Making Printers Available to Your Workstation

You must identify the type of local or remote printer you want to use. Use the Add New Printer command from the Installation menu of the Control Panel.

When you use the Add New Printer command, you identify the name of the printer driver file for the type of printer you want to use. The printer driver file provides information to MS-Windows about how the printer works. From MS-Windows and its applications, you can send files only to printers that have their printer types and driver files named in the Control Panel.

You can add a printer driver file to MS-Windows when you want to:

- Add an existing printer driver file to your WIN.INI file.
- Add a new printer driver file. For information on adding a new driver file, see the *Microsoft Windows User's Guide*.

To add an existing printer driver file to your WIN.INI file:

1. Select the **Add New Printer** command from the Installation menu.

MS-Windows displays the Add Printer dialog box. Figure 2-2 shows the Add Printer dialog box.

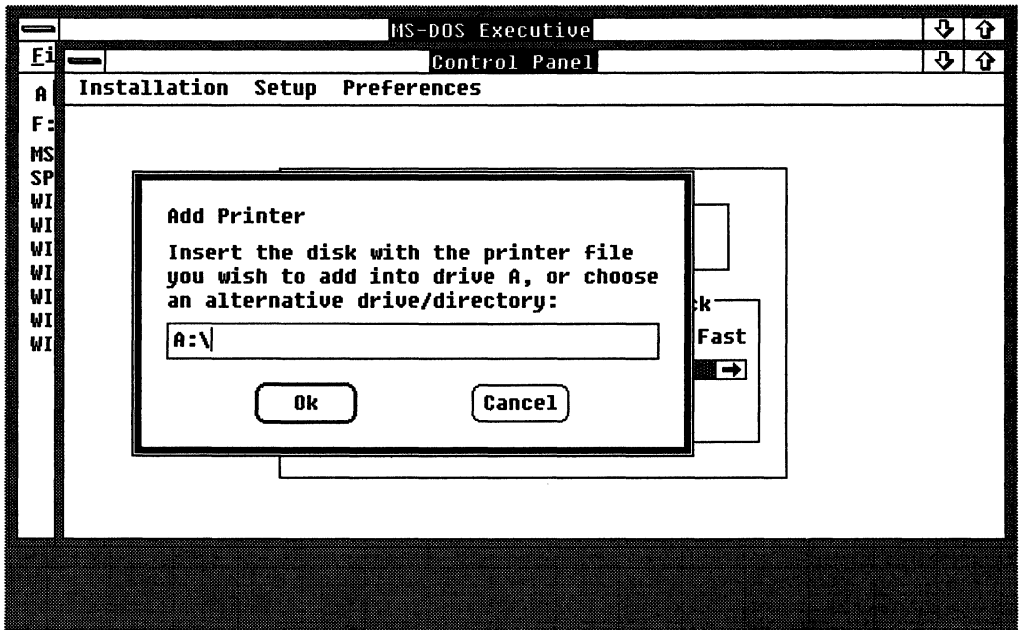

Figure 2-2 Add Printer Dialog Box

2. In the text box, enter the location of the printer driver files. In a PCSA network, the printer driver files are typically L:\WIN\UTIL. For VAXmate standalone workstations, the printer driver files are typically located on drive C:\WIN\UTIL.
3. Click on the Ok command button.

MS-Windows displays a dialog box, listing the printer types available in the selected directory.

4. From the list box, select a printer.

The name of the corresponding printer driver file is displayed in the Printer File text box of the dialog box.

See Table 2-2 for information on selecting printers.

Table 2-2 Selecting Printers

Printer	Printer Type
LA50	Digital LA50
LA75 Companion	Digital LA75DEC
LA210 Letterprinter	Digital LA210DEC
LN03	PostScript
PrintServer 40	PostScript
LN03 Plus with or without CG-Times cartridge	Digital LN03PLUS
LN03 Plus with ISO/PC cartridge	Digital LN03DEC
LA75 Companion to emulate IBM Proprinter	Digital LA75STD
LN03 Plus with ISO/PC cartridge to emulate IBM Proprinter	Digital LN03STD
LA210 Letterprinter to emulate an IBM Proprinter	Digital LA210STD

5. Click on the Add command button.

MS-Windows displays a dialog box.

6. Click on the No command button.

In a network environment, selecting the No command button is the normal procedure. However, if you want to copy the printer driver file to your hard disk, enter the name of the directory you want to copy the file to and select the **Yes** command button.

MS-Windows updates your WIN.INI file to include information for the new printer driver.

If you add a driver file that is already listed in your WIN.INI file, you can remove the duplicate driver file name by selecting the **Delete Printer** command from the Installation menu. Follow the prompts to delete the duplicate driver file. For more information, see the *Microsoft Windows User's Guide*.

Setting Up Your Printer

To set up your printer, select commands from the Control Panel Setup menu. This section explains how to use the Control Panel Setup menu to:

- Tell MS-Windows the printer types associated with the logical devices
- Match printer and serial port settings
- Select default printers and identify printer format settings

Figure 2-3 shows the Setup menu commands.

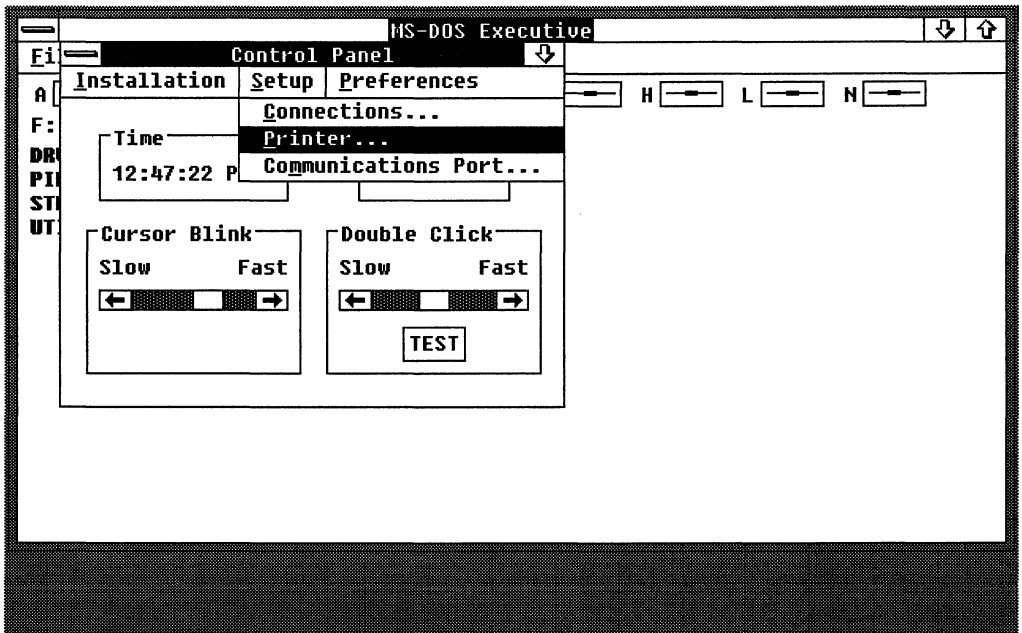

Figure 2-3 Setup Menu Commands

Associating Printer Types and Logical Devices

With the MODE and DECMODE commands, you redirect logical devices to local printer ports. With the USE command, you redirect logical devices to remote printers. With both commands, you must tell MS-Windows which logical devices you are using for your printers.

Use the Connection command in the Setup menu to associate the printer type with the logical device.

To set or change printer connections:

1. Select the **Connection** command from the Setup menu. MS-Windows displays the Connection dialog box, as shown in Figure 2-4.

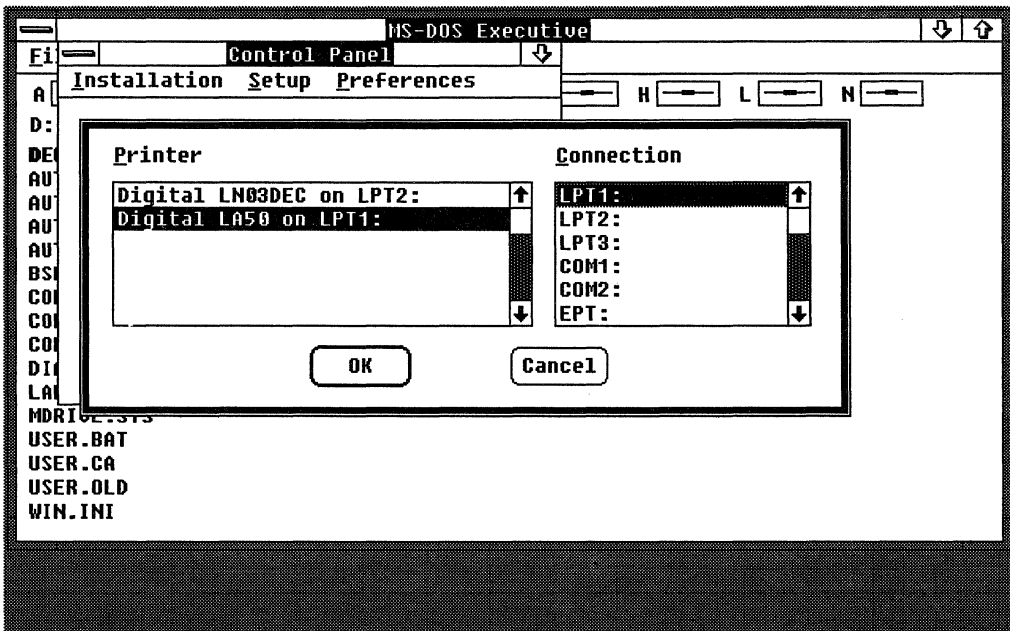

Figure 2-4 Connection Dialog Box

2. From the Printer list box, select the printer type that matches the printer you want to use. The logical device for the selected printer is displayed in the Connection list box, located at the right.

3. From the Connection list box, select one of the logical devices: LPT1, LPT2, LPT3, or COM1. You can associate only one printer type with a logical device.

To cancel a printer type and logical device, select None.

4. Click on the Ok command button.

Matching Printer Port and Printer Settings

Before you can send a file to the local printer, the following printer and workstation ports settings must match:

- Baud rate
- Word length, or data bits
- Parity
- Stop bits
- Handshake, or modem control

NOTE

You must use the MODE command to change the SPP settings to match the printer. For information on the MODE command, see Chapter 3.

Use the Communications Port command on the Control Panel Setup menu to change the communications port settings, even if you have already made the changes using the DOS MODE command. Control Panel settings take effect each time you start MS-Windows.

To change communications port settings:

1. Select the **Communications Port** command from the Setup menu.

MS-Windows displays the Communications Settings dialog box, as shown in Figure 2-5.

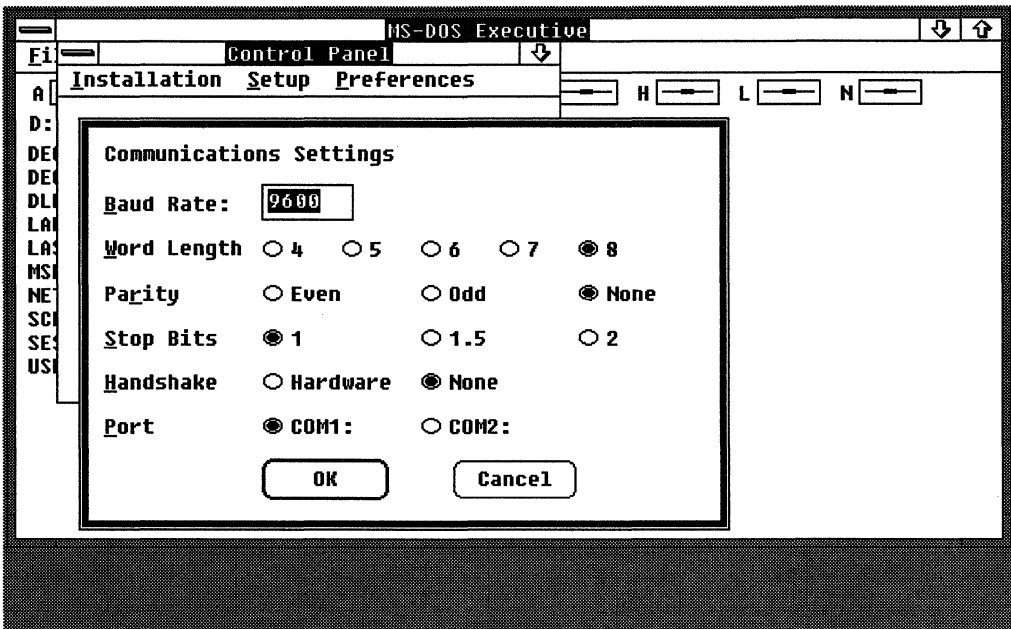

Figure 2-5 Communications Settings Dialog Box

2. Select the communications port COM1 or COM2.

The settings for the selected communications port are displayed in the dialog box.

3. Select the rest of the settings.

The Handshake option “Hardware” is equivalent to XON/XOFF. See your printer documentation for the proper communications port settings.

4. Click on the Ok command button. The communications port you selected is set up.

Selecting a Default Printer

After adding a printer driver file to your WIN.INI file and setting up your local and remote printers, you must tell MS-Windows which printer to use as the default printer. When you use the MS-Windows Print command, the file prints on your default printer.

Your default printer can be either a local printer or remote printer available to your workstation. You select your default printer using the Setup menu Printer command, and you can change your default printer at any time. For information on making a printer available to your workstation, see "Making Printers Available to Your Workstation" in this chapter.

NOTE

When you use the Control Panel to select a remote printer as your default printer, the mode of the your default printer must match the mode of the printer service you set up using Configuration Aide. For example, if your default printer uses portrait mode, the service you use must also print using portrait mode. Otherwise, the results are unpredictable.

To select or change your default printer:

1. Select the **Printer** command from the Setup menu.

MS-Windows displays the Default Printer dialog box, listing all the available printers and associated logical devices. Figure 2-6 shows the Default Printer dialog box.

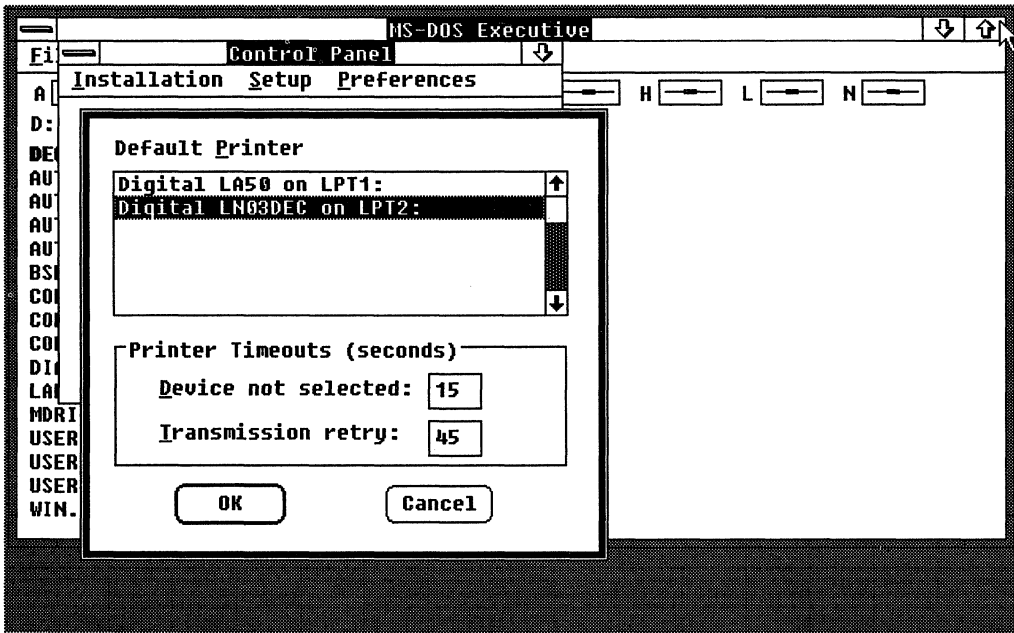

Figure 2-6 Default Printer Dialog Box

2. From the list box, select the printer name.
3. Click on the Ok command button.

MS-Windows displays the Output Mode dialog box, containing the mode settings specific to the printer you selected.

4. Select the options you want. The Output Mode options available depend on your printer.
5. Click on the Ok command button.

The printer you select becomes the MS-Windows default printer.

Printing and Copying Files

Many applications have their own print commands. Whenever possible, use the application print command to send files from an application to a printer. For information on the application print command, see your application documentation.

For applications that do not have print commands, use the MS-Windows Print or Copy commands, listed in Table 2-3. The MS-Windows Print and Copy commands are explained in detail in the following sections.

Table 2-3 Ways to Send Text to a Printer from MS-Windows

Method	Select from...	Description
Print command	MS-DOS Executive File menu	Sends the file to your default printer. Starts the Print Spooler application and sends files to the Spooler, which queues them to the printer.
Copy command	MS-DOS Executive File menu	Copies files directly to the logical device you name.

Using the MS-Windows Print Command

Using the Print command, you can send files to a local or remote default printer.

NOTE

Most applications have a command that prints application files. When possible, you should use the application command to print those files.

To print a text file using the Print command, display the MS-DOS Executive window and:

1. Click on the name of the text file you want to print. You can print one or more files at a time. For information on how to select multiple files, see the *Microsoft Windows User's Guide*.

The file name you select is highlighted.

2. Select the **Print** command from the File menu.

MS-Windows displays the Print dialog box, as shown in Figure 2-7.

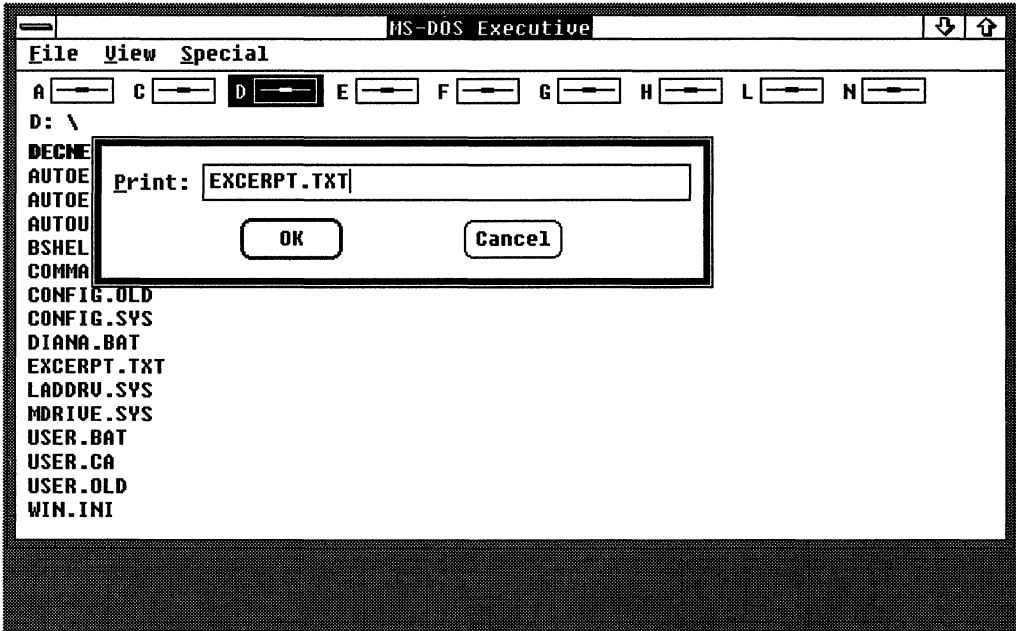

Figure 2-7 Print Dialog Box

If the file name displayed in the Print dialog box is different from the one you want to print, enter the correct file name over the one displayed.

3. Click on the Ok command button.

The MS-DOS Executive window displays the Print Spooler dialog box, which tells you the file is being sent to the Spooler for the default printer.

NOTE

Printing begins after the file has been sent to the Print Spooler. The length of delay before printing begins depends on the complexity and length of the file you are printing, and on the number of other files waiting in the Print Spooler queue.

To cancel a print request, click on the Cancel command button in the Spooler dialog box.

For more information on the Spooler and displaying the status of your print request, see "Controlling the Print Job" in this chapter.

Using the MS-Windows Copy Command

Using the Copy command, you can send files to printers other than the default printer. To print files using the Copy command, display the MS-DOS Executive window and:

1. Click on the names of the files you want to copy. You can copy one or more files at a time. For information on how to select multiple files, see the *Microsoft Windows User's Guide*.

The file names are highlighted.

2. Select the **Copy** command from the File menu.

MS-Windows displays the Copy command dialog box, as shown in Figure 2-8. The file names you selected are shown in the Copy text box.

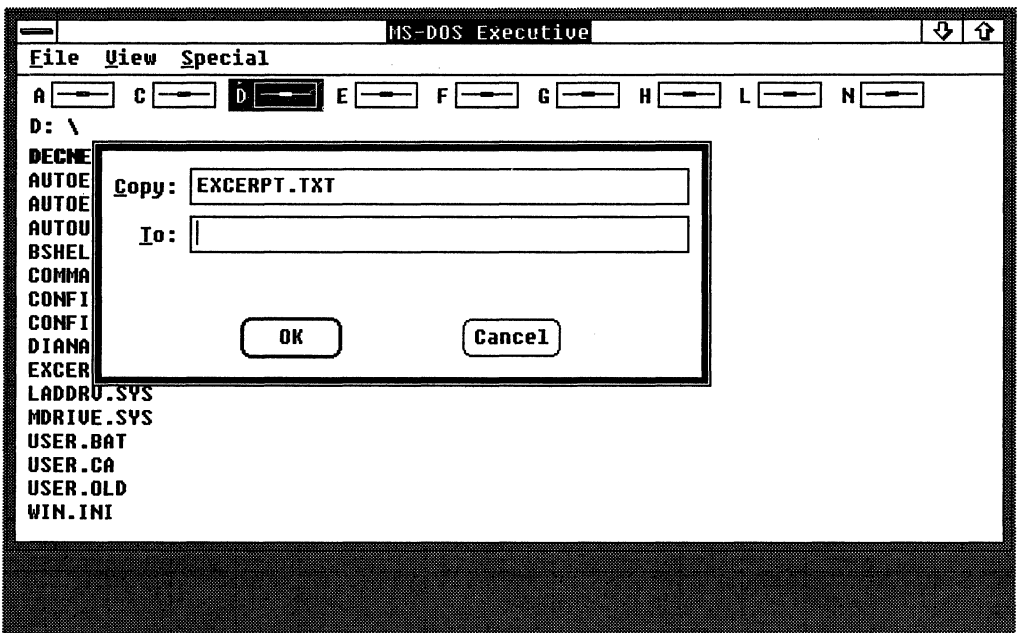

Figure 2-8 Copy Command Dialog Box

3. In the To text box, enter the logical device for the printer you want to use to print the file: LPT1, LPT2, LPT3, or COM1.
4. Click on the Ok command button.

MS-Windows displays a message at the bottom of the Copy dialog box that the file you selected is being copied. When the copying is complete, MS-Windows removes the dialog box from the window.

Controlling the Print Job

The MS-Windows Spooler is an application that stores files waiting in a print queue to be printed and provides commands that let you control printing. When you use the Print command from the MS-DOS Executive window or from a Desktop application:

1. The Spooler application starts.
2. MS-Windows displays the Spooler icon in the icon area.
3. The Print command sends the file to be printed to the Spooler application.
4. The Spooler sends the file to the printer queue. The file starts to print if no other files are printing or waiting to print.

You can perform tasks with other applications while the Spooler application is running.

If you expand the Spooler icon, the Spooler window lists:

- A menu bar with the Priority menu and the Controls menu titles.

Use the commands in these menus to control printing.

- File names in the order they are to be printed.

This listing is the print queue.

The Spooler prints the files one at a time, in the order they are listed. If the listing scrolls off the bottom of your window, use the vertical scroll bar to see the entire list.

- Printers available to the workstation.

The Spooler lists the files waiting to print under the printer on which they will print.

To control printing, use the Priority menu commands and the Control menu commands. With these menu commands you can:

- Allocate the resources devoted to printing or to other applications
- Interrupt or cancel print jobs

The following sections explain the Priority menu commands and the Control menu commands.

Allocating Printing Resources

The Priority menu commands let you allocate resources to the Spooler and other applications. There are two commands, Low and High. A check mark in the menu shows the current setting. Low is the default.

Table 2-4 shows the two Priority menu commands and describes their functions.

Table 2-4 Spooler Priority Menu Commands

Command	Function
Low	Allows other applications you are working with to use more of your workstation resources. Printing has a lower priority and may be slower.
High	Allows the print job to use more of your workstation resources. Your system and the other applications you are using may slow down.

Interrupting or Canceling Print Jobs

The Control menu commands let you interrupt or cancel a print job. For example, you can interrupt a print job to change a printer ribbon. Table 2-5 shows the three Control menu commands and describes what they do.

Table 2-5 Spooler Control Menu Commands

Command	Function
Pause	Interrupts a print job. Changes the printer status in the Spooler window from Active to Paused. The printer stops printing.
Resume	Restarts an interrupted print job. Changes the printer status in the Spooler window from Paused to Active. The printer continues printing.
Terminate	Cancels a print job. MS-Windows displays the Terminate box so you can confirm that you want to cancel the request to print the file.

NOTE

If you cancel a job while it is printing in graphics mode, you may need to reset your printer, by turning it off and then on again, to ensure the buffer is cleared. For more information on resetting your printer, see your printer documentation.

To use the Control menu commands:

1. Select the Spooler window or icon.

The Spooler window displays the printers you are using. The default printer is highlighted.

2. Select the Control menu.
3. Click on the command you want.

The Spooler window display changes to show the state of the printer.

The Spooler application can display information about the status of your printing jobs; for example, the printer can run out of paper. If the Spooler has printer status information to display but the Spooler window or icon is not selected, the title bar or icon flashes. Select the Spooler window or icon to display the message.

Printing to a File

To check that a file has been formatted correctly for printing, you can send the contents of the file to “print” (be stored) in another file. The second file includes modifications made by the printer driver to the “printed” file. The modifications are control characters or formatting commands, as in the case of the PostScript driver, that the driver inserts to control the printer output. When you print to the second file, you can view and edit the contents of the “printed” file (stored now in the second file) to check printing format before sending the file to the printer.

For example, if you are using a PrintServer 40, you could print a document to a file named MANUSCRIPT.PRN. First you set up MS-Windows to use the PostScript driver to process the document. When you print the document, the PostScript driver inserts control characters that are necessary to control the output on the PrintServer 40 in the file MANUSCRIPT.PRN. You can check MANUSCRIPT.PRN to see that the correct control characters are present. When you are ready to produce a paper copy of the document, you can print the file on the PrintServer 40.

To print to a file, you must:

1. Edit the WIN.INI file to add the name of the output file to the Ports section
2. Associate a logical device name (the output file name) with the printer driver you want used
3. Use the Print command to process the file you want “printed”

You must edit the WIN.INI file to set up the file to which you want to print. When you edit the WIN.INI file, you add a command that sends printer output to a file rather than to the default printer. You can edit the WIN.INI file using the MS-Windows Notepad application. Add the following line to the Ports Section of your WIN.INI file:

```
filename.PRN=
```

Where:

filename Is the name you want MS-Windows to assign to the output file created when you print to a file.

For example, you could add the following line to the Ports section of your WIN.INI file:

```
MANUSCRIPT.PRN=
```

You must use the .PRN extension. MS-Windows overwrites the file each time you print to the file.

For more information on the MS-Windows WIN.INI file and on using the Notepad application, see the *Mircosoft Windows User's Guide*.

After you edit the WIN.INI file and close the Notepad application, you must associate the printer type with the file to which you want to direct the printing output. To set the connection:

1. Start the Control Panel.
2. Select the **Connections** command from the Setup menu.
MS-Windows displays the Connections dialog box, as shown in Figure 2-9.

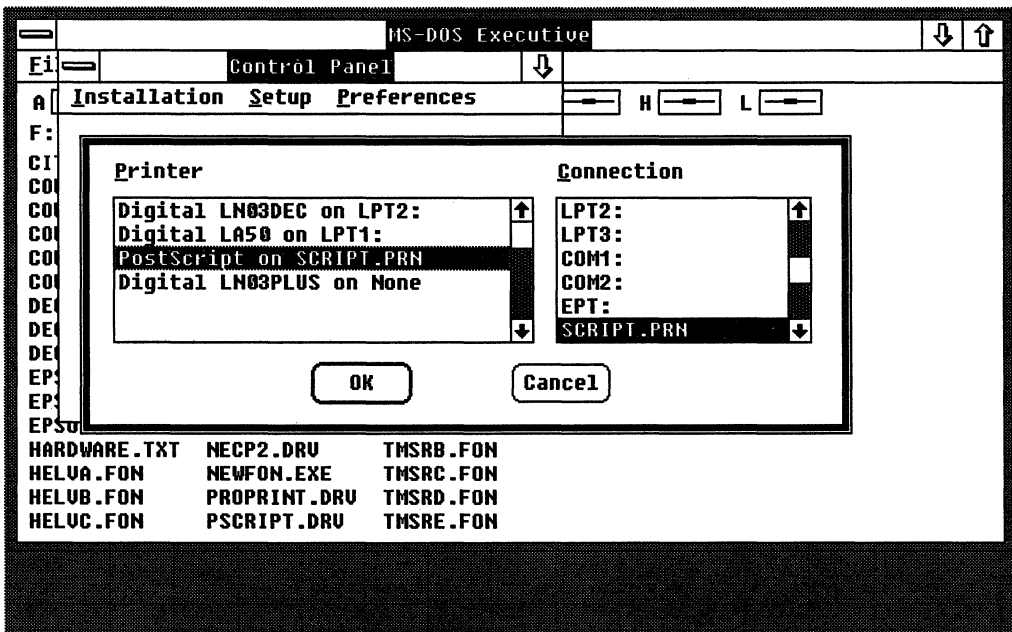

Figure 2-9 Setting Up Connections to Print to a File

3. From the Printer list box, select the printer you want to use when you process your file for printing.
4. From the Connection list box, use the scroll bar to display the file name for the file to which you want to print. Select the file name to associate the printer type and the file name.
5. Click on the Ok command button.

Now use the Printer command from the Setup menu to select the printer type you associated with the .PRN file as your default printer.

MS-Windows is now set up to print to the file. You use the MS-Windows Print command. MS-Windows directs output to the file you named in your WIN.INI file and set up using the Control Panel.

After you check the contents of the "printed" file to see that it contains the correct control characters, you can send the file to the printer. To send the file to the printer, you reset your printer connections and default printer.

NOTE

You can have two of the same printer driver files named in your WIN.INI file. Then you can associate one with the file name you want to use and associate the other with a logical device.

In this way, after printing to a file, you need only reselect your default printer to reprint the file and produce a paper copy.

Printing the Contents of the Screen

With MS-Windows, you can send the contents of your screen to the printer on LPT1. For you to print a screen, the GRAPHICS /R command must be loaded and run before MS-Windows starts. The GRAPHICS /R command is loaded for you with the workstation installation software and should be part of your AUTOEXEC.BAT file, which runs whenever you start your workstation.

If the GRAPHICS /R command is not part of your AUTOEXEC.BAT file, you must either run GRAPHICS /R at the DOS prompt or add the command to your AUTOEXEC.BAT file before you can print screens. You can edit your AUTOEXEC.BAT file using the MS-Windows Notepad application, or by using a text editor, such as EDLIN, at the DOS prompt. If you add the command to your AUTOEXEC.BAT file, you must restart your workstation for the command to take effect.

For more information on the GRAPHICS /R command, see the *MS-DOS Reference Manual*. For information on using Notepad, see the *Microsoft Windows User's Guide*. For information on using EDLIN, see your DOS documentation.

To print your screen, press the Shift/Prt Sc keys.

NOTE

Do not press the Shift/Prt Sc keys if LPT1 is being used by another application. The results are unreliable.

3

Local Printing from DOS

After you start your workstation, you can begin to print right away. VAXmate standalone workstations are configured for using DIGITAL serial printers. In a network, your system administrator is responsible for setting up your workstation for using local printers. However, you can change the way your workstation is set up for local printing from the DOS prompt. Changing the workstation configuration for local printing involves:

- Redirecting logical devices. You must redirect logical devices if you are using serial ports for printers. If you are using parallel ports, the logical devices are assigned automatically.
- Setting printer characteristics. Printer characteristics control the formatting of printed files.
- Setting serial port characteristics. Your printer settings and your workstation port settings must match.

NOTE

To redirect logical devices on a PC workstation, set printer characteristics, and match serial printer and serial port settings, use the DIGITAL DECMODE command. To prepare code pages, use the DOS MODE command. For information on the DOS MODE command, see your DOS reference manual.

In addition, before you can print from a serial printer (such as a DIGITAL serial printer) that can use XON/XOFF protocol and that is connected to your PC workstation, you must run XONXOFF. To know whether your serial printer can use the XON/XOFF protocol, see your printer documentation.

This chapter explains how to use local printers from DOS. Specifically, this chapter covers:

- Redirecting logical devices to printer ports
- Setting printer characteristics

3-2 Local Printing from DOS

- Matching port and printer settings
- Printing and copying files to a local printer
- Controlling the print job
- Printing the contents of the screen

Redirecting Logical Devices to Local Ports

To redirect any of the logical devices, use the MODE command (on a PC workstation, use the DECMODE command) with the format:

```
MODE LPT#=port
```

Where:

LPT# Is the logical device you want to redirect: LPT1 (or PRN), LPT2, LPT3.
port Is the serial port (SPP, COM1, or COM2) or installed parallel port (LPT).

For example, to redirect LPT2 to the serial communications port COM1, enter:

```
C> MODE LPT2=COM1 
```

To cancel any redirection to a serial port and assign LPT1 to an installed parallel port, enter:

```
C> MODE LPT1=LPT 
```

```
Mode Setup Utility Version 1.11
```

```
© Copyright 1985, 1986, 1987, 1988 by Digital Equipment Corporation  
Parallel port redirection canceled successfully.
```

NOTE

When there is no parallel port installed, this command cancels any redirection.

After redirecting LPT1 to a port other than SPP, such as the communications port or to remote printers, you can redirect LPT1 to the Serial Printer Port (SPP), by entering:

```
C> MODE LPT1=SPP 
```

To redirect logical devices on a PC workstation, use the DECMODE command. For example, to redirect LPT2 to the communications port, enter:

```
C> DECMODE LPT2=COM1 
```

For more information about logical devices and redirection, see Chapter 1.

Setting Printer Characteristics

When you connect a serial printer to your workstation, you must use the MODE command to identify the type of printer you are using and to set printing formats. You can set printing formats for the following printers:

- LA50
- LA75 Companion (DEC and STD)
- LN03 Plus
- LN03 Plus with ISO/PC cartridge (DEC and STD)
- LA210 Letterprinter (DEC and STD)
- LJ250 and LJ252 Companion Color Printers (DEC and HP)
- IBM Proprinter (STD)
- IBM Personal Computer Color4 Printer
- IBM Personal Computer Color8 Printer

NOTE

If you are connecting an LA50 to a PC workstation, you must set the XON/XOFF protocol switch on your printer. For information on setting the printer XON/XOFF protocol switch, see your LA50 printer guide.

After setting the XON/XOFF protocol switch on the LA50 printer, you must run the XONXOFF command. For information on the XONXOFF command, see the section, "Matching Printer Port and Printer Settings," in this chapter or the *DOS Enhancements Guide*.

You can identify the printer type and set the printer characteristics each time you start the workstation by including the MODE command in your AUTOEXEC.BAT file. You can use the MS-Windows Notepad application or a DOS text editor such as EDLIN to edit your AUTOEXEC.BAT file. For information on using Notepad, see the *Microsoft Windows User's Guide*. For information on using EDLIN, see your DOS documentation.

3-4 Local Printing from DOS

To specify your printer type and set printing formats, use the **MODE** command, with the format:

```
MODE LPT#, type,width, lpi, retry, qual, bold
```

Where:

- LPT#** Is the logical device for the printer port: LPT1, LPT2, or LPT3. For serial printers connected to the Serial Printer Port (SPP), LPT1 is the default setting.
- type** Is the printer type. To determine the printer type, refer to Table 3-1. If you do not include a printer type, the **MODE** command determines the printer type from the current setting. If there is no current setting, the **MODE** command prompts you for the printer type.
- Printers operating in DEC mode, such as the LA75 Companion printer (type is LA75DEC), the LN03 Plus with ISO/PC cartridge (type is LN03DEC), the LN03 (type is LN03PLUS) and the LA210 Letterprinter (type is LA210DEC), are treated as LA50 printers.
- Printers operating in STD mode, such as the LA75 Companion printer (type is LA75STD), the LN03 Plus with ISO/PC cartridge (type is LN03STD), and the LA210 Letterprinter (type is LA210STD) are treated as IBM Proprinters.
- In DEC mode, the LJ250 Companion Color Printer (type is LJ250DEC) is treated as an LJ250 Companion Color Printer. In HP mode, the LJ250 Companion Color Printer is treated as a Hewlett-Packard ink jet printer.
- width** Is the number of characters to print on each line: 80, 96, or 132 characters. For printer types operating in STD mode, you can specify 80 or 132 characters on a line only.
- lpi** Is the number of lines per inch, either 6 or 8.
- retry** Is the number of times to resend data to the printer if there is a failure. This can be:
- p Keep sending forever
 - Send once and do not try to send again

If you do not use the **retry** parameter, the **MODE** command uses the default (- send once and do not try to send again) or the previous setting. If you have connected the printer to the communications port and redirected a logical device (for example, LPT2) to the communications port, **retry** is enabled on that communications port.

- qual** Is the print quality:
- d Draft quality
 - e Enhanced quality
 - h High-quality resolution
- bold** Is the number of times the print head passes over each printed line. This can be:
- b Bold
 - n Normal

For example, to set up the LA75 Companion printer on LPT1 for 80 characters on a line, 8 lines per inch, continuous retry, draft quality, and normal type, you enter:

```
C> MODE LPT1,LA75,80,8,p,d,n 
```

Table 3-1 Setting Printer Types with MODE command

Printer	Printer Type
LA50	LA50
LA75 Companion	LA75DEC
LN03 Plus LN03 Plus with ISO/PC cartridge	LN03DEC LN03DEC
LA210 Letterprinter	LA210DEC
LJ250 and LJ252 Companion Color Printers	LJ250DEC
LA75 Companion to emulate IBM Proprinter	LA75 or LA75STD
LN03 Plus with ISO/PC cartridge to emulate IBM Proprinter	LN03STD

Table 3-1 (Cont.) Setting Printer Types with MODE command

Printer	Printer Type
LA210 to emulate an IBM Proprinter	LA210STD
LJ250 and LJ252 Companion Color Printers to emulate Hewlett-Packard Ink Jet Printer	LJ250HP
IBM Proprinter	STD
IBM Personal Computer Color4 Printer	COLOR4
IBM Personal Computer Color8 Printer	COLOR8

Comments

You can set the print quality and bolding for some, but not all, printer types. For information on setting print quality and bolding for your printer type, see your printer manual.

You can set printer characteristics each time you start the workstation by including the MODE command in your AUTOEXEC.BAT file. You can use the MS-Windows Notepad application or a DOS text editor such as EDLIN to edit your AUTOEXEC.BAT file. For information on using Notepad, see your Windows documentation. For information on using EDLIN, see your DOS documentation.

To display information about the MODE command formats and parameters, at the DOS prompt, enter:

```
C> MODE 
```

Matching Printer Port and Printer Settings

Before you can send a file to a printer, the following printer and workstation port settings must match:

- Baud rate
- Parity
- Data bits
- Stop bits
- Retry
- Modem control

To send a file to print on a serial printer connected to a PC workstation, you must first run the XONXOFF program by entering:

```
C> XONXOFF 
```

For more information on the XONXOFF program, see the *DOS Enhancements Guide*.

Use the MODE command communications setup to set the VAXmate workstation port settings and the DECMODE command communications setup to set up a PC workstation port settings.

If you use the MODE command, you must reset the workstation ports each time you restart the workstation. To avoid having to reset ports each time you start your workstation, add the MODE command to your AUTOEXEC.BAT file. You can use the MS-Windows Notepad application or a DOS text editor such as EDLIN to edit your AUTOEXEC.BAT file.

However, if you change the type of printer you have connected to the workstation, or if you are using two kinds of printers connected to the workstation, you may have to use this command again. For information on using Notepad, see the *Microsoft Windows User's Guide*. For information on using EDLIN, see your DOS documentation.

The MODE command communications setup has the format:

```
MODE port baud,parity,databits,stopbits,retry,bypass
```

Where:

port Is the serial port: SPP, COM1, or COM2.

3-8 Local Printing from DOS

baud Is the baud rate: 50, 75, 110, 134.5, 150, 300, 600, 1200, 1800, 2000, 2400, 3600, 4800, 7200, 9600, or 19200. The MODE command sets the baud rate to 1200 by default.

parity Is the parity:

- e Even
- o Odd
- n None

The MODE command sets the parity to even by default.

data bits Is the number of data bits: 5, 6, 7, or 8. The MODE command sets the data bits to 7 by default.

stop bits Is the number of stop bits: 1 or 2. The default is 2 for 110 baud and 1 for all others.

retry Is the number of times to resend data to the printer if there is a failure. This can be:

- p Keep sending forever
- Send once and do not try to send again

The MODE command sets retry to send once and do not try to send again (-) by default.

bypass Enables or disables modem control signals:

- m Use modem control signals
- b Bypass modem control signals (equivalent to XON/XOFF protocol)

On a VAXmate workstation, the MODE command default is to use modem control signals.

For example, to set SPP for a printer that runs at 300 baud with even parity, 7 databits, 1 stopbit, continuous retry, and XON/XOFF protocol, enter:

```
C>MODE SPP 300,E,7,1,P,B 
```

Comments

The PORT parameter is the only required parameter. You can list the parameters in any order, separated by commas. If you do not include a parameter, the MODE command sets the default.

The MODE command communications setup defaults are summarized in Table 3-2.

Table 3-2 Default Settings for MODE Command Communications Setup

Setting	Default
Baud rate	1200
Parity	E (even)
Data bits	7
Stop bits	2 for 110 baud; 1 for all others
Retry	- (disabled)
Bypass	M (use modem control)

Printing and Copying Files to a Local Printer

There are two ways to send files to print on a local printer, as shown in Table 3-3. The sections that follow the table provide details on sending files to a local printer.

Table 3-3 Ways to Send Text to a Local Printer

Method	Command Format	Description
PRINT command	PRINT filename.txt	Sets up a local print queue and sends files to the printer.
COPY command	COPY filename.txt LPT#	Copies a file directly to the printer.

Using the PRINT Command

After you have set up your printer using the MODE or DECMODE commands and XONXOFF (for a PC workstation using serial printers), you can start printing files. The PRINT command lets you send a file to the queue for printing locally. While the file prints, you can continue using other commands and programs.

To send files to the printer, use the PRINT command in its simplest form:

```
PRINT filename.txt [, filename.txt, ...]
```

For example, to print the file EXCERPT.TXT, enter:

```
C> PRINT EXCERPT.TXT 
```

3-10 Local Printing from DOS

To print three files, EXCERPT.TXT, STANZA.TXT, and SONNET.TXT, enter:

```
C>PRINT EXCERPT.TXT, STANZA.TXT, SONNET.TXT 
```

To print all files with the extension .TXT, use the wildcard character (*), for example:

```
C>PRINT *.TXT 
```

Comments

The first time you use the PRINT command after starting or restarting your workstation, it prompts you for the logical device. The default is LPT1 or PRN. Press the Enter key in response to the PRINT command prompt. For example:

```
C>PRINT EXCERPT.TXT   
Name of list device [PRN]:   
Resident part of PRINT installed
```

```
      C:\EXCERPT.TXT is currently being printed
```

By adding the PRINT command (with the information about the logical device for your local printer) to your AUTOEXEC.BAT file, you can stop the PRINT command from prompting for information. For example, you can add the following command to your AUTOEXEC.BAT file:

```
PRINT /D:LPT1
```

To control aspects of the print job, you can use additional PRINT command parameters. For information on these parameters, see the section, "Controlling the Print Job," in this chapter, and the *MS-DOS Reference Manual*.

Using the COPY Command

The COPY command lets you copy a file to the printer without first sending the file to a print queue. When you copy a file to the printer, you must wait until the file finishes printing before you can continue using other commands or programs.

To copy a file to the local printer, use the COPY command in the form:

```
COPY filename.txt LPT#
```

Where:

filename Is the file name, including the drive name and path of the file you want to copy to the printer. If you do not include the drive, the COPY command uses the current drive. If you do not include the path, the PRINT command uses the current directory. You can use the wildcard characters to copy multiple files with the same file name or file extension.

LPT# Is the logical device for the printer port.

For example, to print the file EXCERPT.TXT by copying it to the printer connected to LPT1, enter:

```
C> COPY EXCERPT.TXT LPT1 
```

To copy all files with the .TXT extension to the printer, use the wildcard (*) for the file name and specify the .TXT extension. For example:

```
C> COPY *.TXT LPT1 
```

Controlling the Print Job

When you use the PRINT command to send files to the printer, the PRINT command creates a print queue into which it puts the files you want to print. A single file starts to print immediately. Additional files wait in the queue for their turn to print. You can remove specific, named files from the print queue or remove all the files in the queue. In addition, you can check the status of the print queue. The following sections explain the commands you use to control the print job.

Remove Files by Name from the Print Queue

To remove a single named file or multiple named files from the print queue, use the PRINT command with the following format:

```
PRINT filename.txt /C
```

Where:

filename.txt Is the full file name, including the drive name and path of the file you want to remove from the print queue.

/C Removes from the print queue the file named to the left of the /C and all the files named to the right of /C.

For example, to remove the files EXCERPT.TXT and PROSE.TXT from the print queue, enter:

```
C> PRINT /C EXCERPT.TXT, PROSE.TXT 
```

Remove All Files from the Print Queue

You can remove all files waiting in the print queue by using the PRINT command with the following format:

```
PRINT /T
```

Where:

/T Removes from the print queue all files waiting to be printed and stops printing the remainder of any file currently being printed.

For example, to empty the print queue, enter:

```
C> PRINT /T 
```

```
PRINT queue is empty
```

Show Printer Queue Status

To show printer queue status, use the PRINT command without a filename. For example:

```
C> PRINT 
```

Printing the Contents of the Screen

There are two ways to print the contents of the screen on a local printer, as shown in Table 3-4.

Table 3-4 Ways to Send Screen Contents to a Local Printer

Method	Command Format	Description
Print Screen	Shift/Prt Sc	Prints the current full-screen image to LPT1.
Line Echo	Ctrl/P	Prints whatever is displayed on the screen, character by character, to LPT1. Press the Ctrl/P keys once to turn Line Echo on; press the Ctrl/P keys a second time to turn Line Echo off.

NOTE

You can print graphics using the following printers:

- **LA50**
- **LA75 Companion (DEC and STD)**
- **LN03 Plus**
- **LN03 Plus with ISO/PC cartridge (DEC and STD)**
- **LA210 Letterprinter (DEC and STD)**
- **LJ250 and LJ252 Companion Color Printers(DEC)**
- **IBM Proprinter (STD)**
- **IBM Personal Computer Color4 Printer**
- **IBM Personal Computer Color8 Printer**

To use the Shift/Prt Sc keys to print screen graphics, the GRAPHICS command must first be loaded and run. The GRAPHICS /R command is loaded for you with the workstation installation software and should be part of your AUTOEXEC.BAT file, which runs whenever you start your workstation.

If the GRAPHICS command is not part of your AUTOEXEC.BAT file, or if the GRAPHICS /R command is in your AUTOEXEC.BAT file (for printing screens from MS-Windows), you must either run GRAPHICS at the DOS prompt or add the command to your AUTOEXEC.BAT file before you can print screens. If you add the command to your AUTOEXEC.BAT file, you must restart your workstation for the command to take effect. For more information on the GRAPHICS command, see the *MS-DOS Reference Manual*.

You can use the MS-Windows Notepad application or a DOS text editor such as EDLIN to edit your AUTOEXEC.BAT file. For information on using Notepad, see your *Microsoft Windows User's Guide*. For information on using EDLIN, see your DOS documentation.

4

Remote Printing from DOS

Before you can print a file on a remote printer, you must:

1. Connect to the network

The NET START RDR and the NET START RDR802 commands connect your workstation to the network.

For information on using NET START RDR and NET START RDR802, see *Using Networks from Your Workstation*.

2. Connect to a printer on a server

The NET USE command redirects a logical device to the remote printer you want to use.

NOTE

Your system administrator should include the necessary commands on your key diskette or key disk and can tell you the service names of the remote printers available to you.

The following sections describe how to:

- Redirect a logical device to a remote printer
- Set up a default printer on the network
- Send a file to the remote printer
- Check print queue status
- Disconnect from a remote printer

Redirecting a Logical Device to a Remote Printer

To connect to a remote printer, you must redirect a logical device to the printer.

After you connect to a remote printer, you can display a list of the remote printers you can connect to by entering the NET USE command without specifying a printer. The NET USE command lists all the remote services you are connected to, including remote printers.

To redirect a logical device to the remote printer, use the NET USE command, with the format:

```
NET USE LPT# \\nodename\servicename%username [password |*]
```

Where:

LPT#	Is the logical device you want to assign: LPT1 (or PRN), LPT2, or LPT3. Each logical device can be assigned to only one printer at a time. However, more than one logical device can be assigned to a single printer.
nodename	Is the DECnet node name for the server from which the printer runs. You must include a space and two backslashes (\\) before the node name.
servicename	Is the service name for the remote printer. A single backslash (\) separates the node name from the service name.
username	Is the username for the VAX/VMS account that you are using. A percent sign (%) separates the service name from the username.
password	Is the password associated with the username you supply.
*	Prompts you for the password, if you do not supply it. When you type the password to respond to the prompt, the password is not displayed on the screen. You can use the asterisk (*) for security.

For example, the following command lets you connect to printer device LPT2, for the SARLAT account with the service name LN03_DPORT, on a remote server named MUSE, and prompts for the password:

```
C>NET USE LPT2 \\MUSE\LN03 DPORT%SARLAT * 
```

Comments

To display a list of the remote printers you have connected to, use the NET USE command without specifying a printer. The command lists all the remote resources you are connected to, including the remote printers. For example:

```
C> NET USE 
USE Utility Version 2.0 [Virtual drives: D:-G:]
```

Local Status	Device	Service Type	Service Name	Access
D		DISK	\\MUSE\POET	
H		FILE	\\MUSE\VXSYS	
I		FILE	\\MUSE\WRITER	
K		FILE	\\MUSE\PCAPP	
LPT1:		FILE	\\MUSE\LN03_DPORT	

Command completed successfully.

When you connect a logical device to a remote printer, that connection supersedes any local redirection. After you disconnect from a remote printer, any local redirection of the logical device takes effect again.

To temporarily disconnect all remote printers, use the command:

```
C> NET PAUSE PRDR 
```

To reconnect the remote printers, enter:

```
C> NET CONTINUE PRDR 
```

Some applications and commands print only to LPT1. For this reason, if you want applications to print to a local printer, you should connect to the remote printers using LPT2 or LPT3. In this way, you can avoid redirecting LPT1 each time you want to switch between the local and remote printer.

Setting Your Default Remote Printer

You can set a remote printer as your default so that you always connect to it when you start the workstation. To set up a remote printer as your default printer, add to your AUTOEXEC.BAT file the commands described in Table 4-1.

Table 4-1 Network Commands for Setting Default Remote Printers

Command	Function
NET START RDR NET START RDR802	Starts the network
NET USE printer alias	Associates the printer device you want to use the network printer

The network must start before you can begin to use a remote printer. Put the NET START RDR command before the NET USE command in your AUTOEXEC.BAT file.

After editing your AUTOEXEC.BAT file, you must restart your workstation for the new commands to take effect.

Sending a File to a Remote Printer

When you send a file to a remote printer, the workstation uses the printer as if it were local. To send files to a remote printer, you can use:

- MS-Windows commands
- DOS commands
- NET PRINT command

The MS-Windows and DOS commands you can use to print to a remote printer are the same as the commands you use with a local printer. For more information on the MS-Windows and DOS commands, see Chapters 2 and 3.

The following section explains how to use the NET PRINT command from DOS to send a file to a remote printer.

Using the NET PRINT Command

To send a file to a remote printer on the server, use the NET PRINT command from the DOS prompt, with the format:

```
NET PRINT filename.txt LPT#
```

Where:

filename.txt Is the name of the ASCII text file you want to print.

LPT# Is the logical device assigned to the remote printer you want to use: LPT1 (or PRN), LPT2, or LPT3.

For example, to print the file EXCERPT.TXT on the remote printer LPT2, enter:

```
C> NET PRINT EXCERPT.TXT LPT2 
```

Comments

When you use NET PRINT to send a file to the remote printer, the file goes to a print queue on the server. The following section provides information on checking the remote print queue status.

Checking Print Queue Status

Table 4-2 shows how to use the NET PRINT command to check the status of the:

- Queue of a printer you identify by logical device
- Queue of a printer you identify by service name
- Server default print queue

Table 4-2 Commands for Checking Print Queue Status

To check the status of...	Use the command...
Printer queue identified by logical device	NET PRINT LPT#
Printer queue identified by service name	NET PRINT \\nodename\servicename
Server default print queue	NET PRINT \\nodename

For example, to show the queue status of the printer with the logical device LPT2, enter:

```
C> NET PRINT LPT2 
```

Disconnecting from a Remote Printer

To disconnect from a remote printer, use the NET USE command with the /D qualifier. You must disconnect a logical device from a remote printer before you can redirect it to another printer. For example, if you have redirected LPT2 to a remote printer and then decide to use LPT2 for a local printer connected to COM2, you must first disconnect LPT2 from the remote printer before redirecting it to the local printer port. To disconnect LPT2 from a remote printer, enter:

```
C>NET USE LPT2 /D 
```

Table 4-3 shows the steps you follow and the commands you use to redirect logical devices.

Table 4-3 How to Redirect a Remote Printer

Step	Purpose	Command
1	Disconnect from the remote printer.	NET USE LPT# /D
2	Connect to a different remote printer.	NET USE LPT# \\nodename\device

To redirect LPT2 to QUILL instead of SCRIPT, enter:

```
C>NET USE LPT2 /D   
Command completed successfully.
```

```
C>NET USE LPT2 \\MUSE\QUILL   
Command completed successfully.
```

Index Key

Symbol	Meaning
f	Information is found in a figure.
t	Information is found in a table.

A

Adding printers to MS-Windows,
2-4

Applications

- printing from, 1-8
- printing screen displays, 1-9
- selecting default printers from,
1-9
- selecting printer types, 1-8
- using LPT1, 1-9

AUTOEXEC.BAT

- changing in MS-Windows, 2-1
- for connecting to remote printers,
4-3
- setting serial printer port
characteristics, 1-5, 3-3

B

Baud rates, 1-4

- default VAXmate workstation
settings, 1-5t
- setting for serial printer port,
2-10, 3-3

Before using remote printers, 4-1

C

Canceling print jobs

- in DOS, 3-11
- in MS-Windows, 2-17

Canceling redirection in DOS, 3-2

Changing printer priorities from
MS-Windows, 2-17

Checking remote print queue status
from DOS, 4-5

Communications ports, 1-3

- default VAXmate workstation
settings, 1-5t

Communications ports (cont'd.)

- setting port characteristics in
DOS, 3-3
- setting port characteristics in
MS-Windows, 2-10

COM ports

See Communications ports

Connecting a remote printer from
DOS, 4-1

Connecting to the network from
DOS, 4-1

Controlling local print jobs from
DOS, 3-11

Controlling print jobs from
MS-Windows, 2-16

Control Panel

associating printers and logical
devices, 2-8

for changing MS-Windows
WIN.INI file, 2-2

for printing to a file in
MS-Windows, 2-19

functions of Installation and
Setup menus, 2-3t

matching printer port and printer
settings, 2-9

selecting default printers, 2-11

setting port characteristics in
MS-Windows, 2-10

Setup menu, 2-7

COPY command (DOS)

sending files to local printers,
3-9, 3-10

Copy command (MS-Windows),
2-15

Copying files to a local printer from
DOS, 3-9

Ctrl/P

Ctrl/P (cont'd.)

- in DOS, 3-12t
- printing application screen displays, 1-9

D

- Data bits, 1-4
 - setting for serial printing ports in DOS, 3-8

- DEC mode
 - defined, 1-8

- DECMODE command
 - See also* MODE command
 - canceling logical devices, 3-2
 - matching printer port and local printer settings, 3-7
 - MS-Windows and, 2-1, 2-9
 - redirecting logical device names, 3-2
 - setting local printer characteristics, 3-3

- Default printers
 - selecting in MS-Windows, 2-11
 - setting remote printers in AUTOEXEC.BAT file, 4-3

- Deleting files from the local print queue (DOS), 3-11
- Deleting files from the print queue (MS-Windows), 2-18t
- Disconnecting from a remote printer, 4-3, 4-6
 - NET PAUSE PRDR, 4-3

H

- Hewlett-Packard emulation (HP)
 - from DOS, 3-4
- HP mode
 - defined, 1-8
 - from DOS, 3-4

I

- IBM Personal Computer Color4 Printer, 3-13
 - setting local printer characteristics in DOS, 3-3

- IBM Personal Computer Color8 Printer, 3-13
 - setting local printer characteristics in DOS, 3-3

- IBM Proprinter (STD)
 - setting local printer characteristics in DOS, 3-3

- IBM Proprinter emulation, 1-8
 - from DOS, 3-6t
 - from MS-Windows, 2-6t
 - printing from applications, 1-8
- Interrupting print jobs
 - in MS-Windows, 2-17

L

- LA210 Letterprinter (DEC and STD)
 - DEC and STD modes defined, 1-7
 - selecting printer type in applications, 1-8
 - selecting printer types in MS-Windows, 2-6t
 - setting local printer characteristics in DOS, 3-3

- LA50
 - setting local printer characteristics in DOS, 3-3

- LA75 Companion (DEC, STD)
 - DEC and STD modes defined, 1-8
 - selecting printer type in applications, 1-8
 - selecting printer types in MS-Windows, 2-6t
 - setting local printer characteristics in DOS, 3-3

- Line echo
 - defined,, 1-9
 - in applications, 1-9
 - printing screen displays character by character in DOS, 1-9

- Listing remote resources
 - NET USE command, 4-2

- LJ250 Companion Color Printer (DEC and HP)

- LJ250 Companion Color Printer (DEC and HP) (cont'd.)
 - setting local printer characteristics in DOS, 3-3
- LJ252 Companion Color Printer (DEC and HP)
 - DEC and HP modes defined, 3-3
 - setting local printer characteristics in DOS, 3-3
- LN03
 - selecting printer type in MS-Windows, 2-6t
 - setting local printer characteristics in DOS, 3-3
- LN03 Plus
 - DEC and STD modes defined, 1-7
 - selecting printer type in MS-Windows, 2-6t
 - setting local printer characteristics in DOS, 3-3
- Local printers
 - canceling redirection in DOS, 3-1
 - defined, 1-1
 - printing files from DOS, 3-9
 - printing files from MS-Windows, 2-12
 - redirecting logical devices from DOS, 3-1
 - selecting default printers in MS-Windows, 2-11
 - setting printer characteristics in DOS, 3-3
- Local printing
 - controlling the print job with the MS-Windows, 2-15
 - controlling the print job with the MS-Windows Spooler, 2-16
 - controlling the print job with the PRINT command, 3-9
 - copying files in DOS, 3-9
 - copying files in MS-Windows, 2-13
 - deleting files from the local print queue (DOS), 3-12
- Local printing (cont'd.)
 - deleting files from the print queue (MS-Windows), 2-18t
 - DOS PRINT command, 3-9t
 - printing files in DOS, 3-7
 - printing files in MS-Windows, 2-13
 - printing screens in DOS, 3-12
 - printing screens in MS-Windows, 2-21
 - printing to a file in MS-Windows, 2-19
 - setting serial printer port characteristics, 3-4
- Local print queues
 - deleting files from the queue from MS-Windows, 2-18t
 - deleting files in the queue from DOS, 3-11
 - MS-Windows Print Spooler, 2-16
- Logical devices, 1-1, 1-6, 1-7
 - canceling redirection in DOS, 3-1
 - checking remote print queue status from DOS, 4-5
 - default assignments, 1-7
 - defined, 1-2
 - local printers and, 1-6
 - redirecting for local printers in DOS, 3-1
 - redirecting to print to a file in MS-Windows, 2-19
 - redirecting to remote printers from DOS, 4-2
 - remote printers and, 1-6
 - using in MS-Windows, 2-8
- LPT1, 1-9
 - application use of, 1-9
 - printing screens in MS-Windows, 2-21
 - redirecting to remote printers from DOS, 4-2
 - redirecting to SPP in DOS, 3-1

M

- Matching local printer and port settings
 - in DOS, 3-7
 - in MS-Windows, 2-9
- MODE command
 - See also* DECMODE command
 - canceling logical devices, 3-2
 - matching printer port and local printer settings, 3-7
 - MS-Windows and, 2-1, 2-9
 - redirecting logical device names, 3-2
 - redirecting logical devices
 - in MS-Windows, 2-8
 - serial printer port setting defaults, 3-8t
 - setting local printer characteristics, 3-3
- Modem control
 - bypass modem control signals, 3-8
 - setting for serial printing ports in DOS, 3-8

N

- NET PAUSE PRDR command, 4-3
- NET PRINT command, 4-4
 - checking remote printer queue status from DOS, 4-4
- NET START RDR802, 4-1
- NET START RDR command, 4-1
- NET USE command, 4-2
 - disconnecting from a remote printer in DOS, 4-6
 - listing remote resources, 4-2
 - redirecting logical devices for remote printers, 4-2
- Network printers
 - See* Remote printers

P

- Parallel ports
 - defined, 1-3

- Parity, 1-4
 - setting for serial printing ports in DOS, 3-8
- Physical device defined, 1-3
- Ports
 - parallel, defined, 1-3
 - serial, defined, 1-3
- PRINT command (DOS), 3-9
 - clearing the local printer queue, 3-12
 - controlling local printing, 3-11
 - deleting a file from the local print queue, 3-11
- Print command (MS-Windows)
 - printing files, 2-13
 - spooler, 2-16
- Printer driver files
 - adding to WIN.INI, 2-4
 - defined, 1-7
- Printer ports, 1-3
- Printer types, 1-7
 - selecting in MS-Windows, 2-6
- Printing multiple files on a local printer, in DOS, 3-9
- Printing process overview, 1-2f
- Printing screens
 - from applications, 1-8
 - from DOS, 3-12
 - from MS-Windows, 2-21
- Printing to a file, 2-19
- Priority menu
 - controlling print job priority, 2-17

R

- Redirecting logical devices
 - for local printers from DOS, 3-2
 - for remote printers, 4-2, 4-6
 - in MS-Windows, 2-1, 2-8
- Redirection
 - defined, 1-3
- Remote print
 - restarting interrupted print jobs in MS-Windows, 2-18t

- Remote printers
 - before using, 2-1, 4-1
 - connecting from DOS with the NET USE command, 4-3
 - controlling the print job with the MS-Windows Spooler, 2-16
 - defined, 1-1
 - deleting files from the print queue in MS-Windows, 2-18t
 - disconnecting from DOS, 4-6
 - for use in MS-Windows, 2-8, 2-11
 - NET PAUSE PRDR command, 4-3
 - NET PRINT command, 4-4
 - queue status from DOS, 4-5
 - redirecting logical devices, 4-2, 4-6
 - selecting default printers, 2-11
 - sending a file to, from DOS, 4-4
 - setting defaults in
 - AUTOEXEC.BAT file, 4-3
 - temporarily disconnecting from DOS, 4-3
- Remote printer services, 1-6
- Remote print queues, 4-6
- Retry, 3-4
- S**
- Selecting default printers
 - from MS-Windows applications, 1-9
 - in MS-Windows, 2-11
- Serial communications port, 1-3
 - location on VAXmate, 1-4f, 1-5
 - VAXmate default settings, 1-5t
- Serial ports
 - defined, 1-3
- Serial Printer Port (SPP), 1-3
 - default VAXmate workstation settings, 1-5t
 - location on VAXmate, 1-4f
 - logical device assignment, 1-7
 - matching settings with printer settings in DOS, 3-3
- Serial Printer Port (SPP) (cont'd.)
 - matching settings with printer settings in MS-Windows, 2-9
 - redirecting logical devices from DOS, 3-2
 - setting port characteristics, 1-4
 - VAXmate default settings, 1-5t
- Setting bold or normal printing for local printers in DOS, 3-5
- Setting default printers
 - in MS-Windows, 2-11
 - remote printers in DOS, 4-3
- Setting lines per inch in DOS for local printers, 3-5
- Setting line width in DOS for local printers, 3-4
- Setting local printer characteristics in DOS, 3-3 to 3-6
- Setting local printer type in DOS, 3-3
- Setting printing priorities in MS-Windows, 2-17
- Setting print quality in DOS, 3-5
- Setting serial port
 - AUTOEXEC.BAT file, 3-3
 - characteristics in DOS, 3-3
- Shift/Prt Sc keys
 - printing application screen displays, 1-9
 - printing screens in DOS, 3-12t
 - printing screens in MS-Windows, 2-21
- Spooler, 2-16
 - canceling print jobs, 2-18t
 - controlling print jobs, 2-16
 - deleting files from the print queue in MS-Windows, 2-18t
 - interrupting print jobs, 2-18t
 - MS-Windows print command and, 2-13
 - Priority menu commands, 2-17
 - restarting interrupted print jobs, 2-18t
- SPP *See* Serial Printer Port
- STD mode, 1-8

6 Index

Stop bits, 1-4
 setting serial printing ports in
 DOS, 3-8

V

VAXmate ports, 1-3

W

WIN.INI file, 2-1
 adding printer driver files, 2-4
 changing, 2-2, 2-19

X

XONXOFF program, 3-1, 3-3, 3-8
 how to run, 3-9

READER'S COMMENTS

Your comments and suggestions help us to improve the quality of our publications.

For which tasks did you use this manual? (Circle your responses.)

- (a) Installation (c) Maintenance (e) Training
 (b) Operation/use (d) Programming (f) Other (Please specify.) _____

Did the manual meet your needs? Yes No Why? _____

Please rate the manual in the following categories. (Circle your responses.)

	Excellent	Good	Fair	Poor	Unacceptable
Accuracy (product works as described)	5	4	3	2	1
Clarity (easy to understand)	5	4	3	2	1
Completeness (enough information)	5	4	3	2	1
Organization (structure of subject matter)	5	4	3	2	1
Table of Contents, Index (ability to find topic)	5	4	3	2	1
Illustrations, examples (useful)	5	4	3	2	1
Overall ease of use	5	4	3	2	1
Page Layout (easy to find information)	5	4	3	2	1
Print Quality (easy to read)	5	4	3	2	1

What things did you like *most* about this manual? _____

What things did you like *least* about this manual? _____

Please list and describe any errors you found in the manual.

Page	Description/Location of Error
_____	_____
_____	_____
_____	_____

Additional comments or suggestions for improving this manual: _____

Name _____	Job Title _____
Street _____	Company _____
City _____	Department _____
State/Country _____	Telephone Number _____
Postal (ZIP) Code _____	Date _____

Fold Here and Tape -----

Affix
Stamp
Here

DIGITAL EQUIPMENT CORPORATION
CORPORATE USER PUBLICATIONS
200 FOREST STREET MR01-2/L12
MARLBOROUGH, MA 01752-9101

Fold Here -----